



**FROM
CONCEPT TO
CREATION**

**IBUILDING
CONTRACTING**

COMPANY PROFILE

2025

www.ibuildingco.com

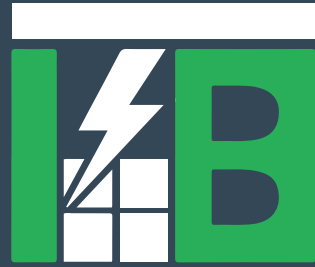

شركة بناء الطاقة للمقاولات
IBuilding Contracting Co

INDEX

MESSAGE FROM MANAGEMENT	04
ABOUT IBUILDING	05
VALUES	07
OUR SERVICES	08
◦ CONSTRUCTION WORK	09
◦ PROPERTY FINISHING	18
◦ ELECTROMECHANICAL WORKS	44
◦ RENTAL GENERATORS	57
◦ MAINTENANCE & INSTALLATION	60
◦ STEEL FABRICATION	66
OUR PARTNERS	67
CONTACT US	69
OUR LOCATION	70

MESSAGE

From Management

Welcome to ibuilding,

At ibuilding, we regard every project as an opportunity to build not just structures but enduring relationships. With over 18 years of experience in engineering and construction, our reputation is founded on quality, reliability, and innovation.

We are committed to adopting the latest technologies, including smart home automation and sustainable practices, to enhance the functionality of our projects. Our client-centric approach ensures transparency and collaboration throughout every phase, aligning our efforts with your vision.

Our diverse services—from construction and property finishing to electromechanical works—allow us to meet the needs of various sectors with professionalism and skill. Your satisfaction is our priority.

As we look to the future, we remain dedicated to delivering excellence in every project. Thank you for considering ibuilding as your trusted partner.

Warm regards,

MANAGEMENT TEAM



About iBuilding

iBuilding is a leading engineering company with over 18 years of experience in delivering high-quality construction, property finishing, and electromechanical solutions. With a strong presence in Egypt and Saudi Arabia, iBuilding has established itself as a trusted partner for innovative and reliable engineering services. Our expertise spans a wide range of disciplines, including construction, interior and exterior design, smart home automation, electromechanical works, steel fabrication, and rental generators.

We pride ourselves on our commitment to excellence, attention to detail, and ability to deliver projects on time and within budget. Our team of skilled professionals, Whose ensures that every project meets the highest standards of quality and safety.



OUR VISION

To be recognized as a leader in the engineering and construction industry, known for our innovative approaches and exceptional service. We aspire to redefine the standards of quality & reliability, contributing to sustainable development and improving the quality of life in the communities we serve.



OUR MISSION

To provide innovative & high-quality engineering & construction solutions that enhance the built environment. We strive to exceed client expectations through integrity, collaboration, and a commitment to excellence, ensuring each project reflects our dedication to sustainability and safety.

VALUES

We believe that adhering to our core values and business ethics is essential in pursuing this business. Our core values include:



**Social Responsibility
& Accountability**



**Creativity
and Innovation**



**Commitment
& Integrity**



Professionalism

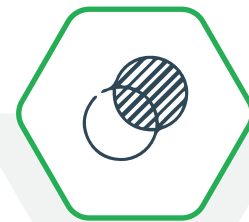

Transparency



OUR SERVICES

IBuilding Contracting Co

- 01** Construction Work
- 02** Property Finishing
- 03** Electromechanical Works
- 04** Rental Generators
- 05** Maintenance & Installation
- 06** Steel Fabrication



Construction Work

iBuilding specializes in comprehensive construction services, from initial planning to final execution. We handle projects of all scales, ensuring structural integrity, functionality, and aesthetic appeal. Our construction services include:

- Building Construction: Residential, commercial, and industrial projects.
- Project Management: End-to-end management of construction projects, including scheduling, budgeting, and quality control.
- Site Preparation: Land surveying, excavation, and foundation work.
- Structural Engineering: Design and implementation of robust structural systems.
- Quality Assurance: Adherence to international standards and local regulations.



CONSTRUCTION



IBuilding Contracting Company provides construction and building services & management of construction projects. Efforts are focused on establishing many high quality & efficient projects through an integrated engineering, technical & administrative team.

We gained our experience over the years through the establishment of many luxury residential buildings such as palaces, residential and commercial complexes and villas.

Where the company has an integrated work team with scientific & practical experience & has the ability to provide solutions and studies the architectural and construction challenges facing clients projects, where we offer the latest technologies and solutions to manage work sites.



WE HANDLE

PROJECTS OF ALL SCALES

We handle projects of all scales, ensuring structural integrity, functionality, and aesthetic appeal.





WE HAVE

**THE BEST
ENGINEERS**

OUR PROJECTS

Construction Work



MOUNTAIN VIEW I-CITY

NEW CAIRO

As a trusted subcontractor, we take pride in our contribution to Mountain View I-City New Cairo, a prestigious development that embodies innovation, sustainability, and luxury. From the initial planning phases to the final delivery

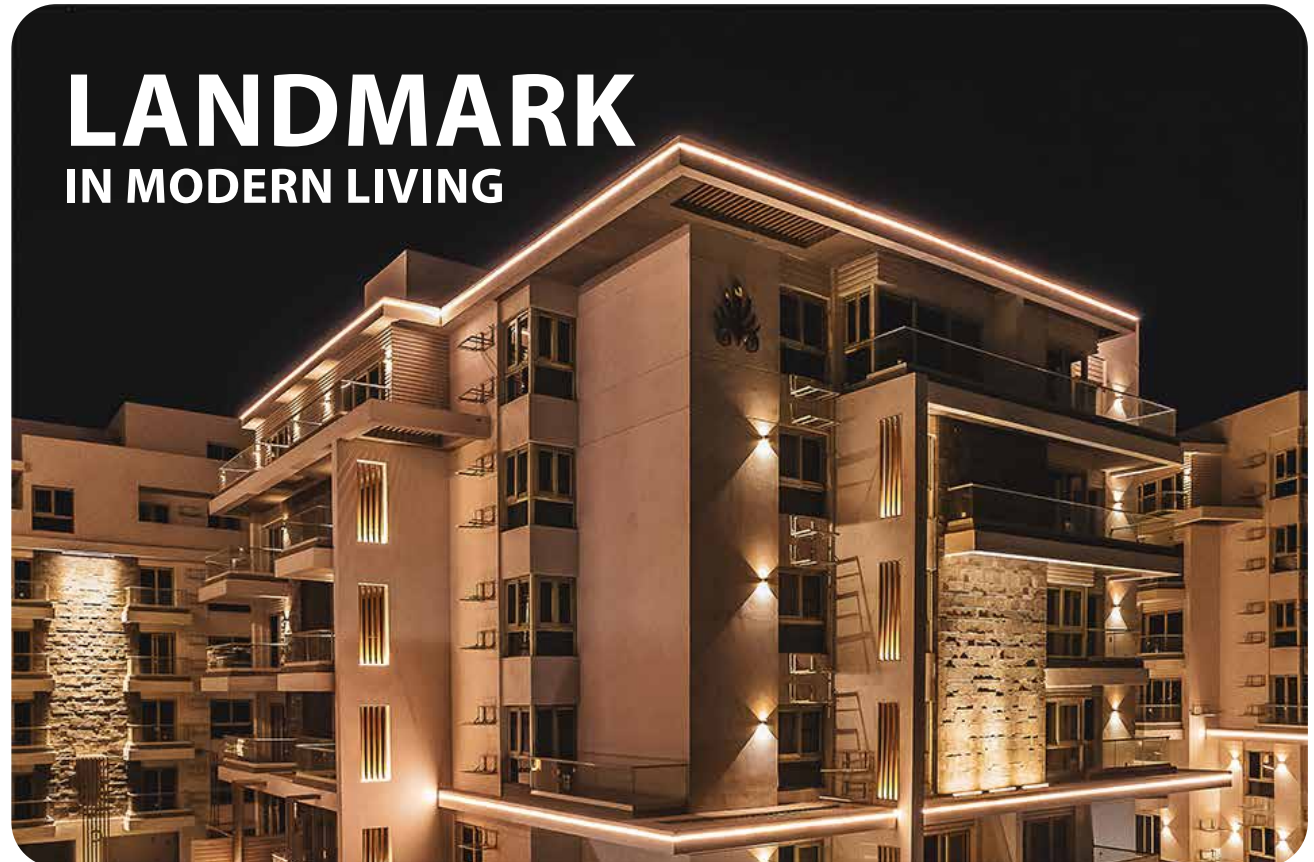



SQUARE MALL PROJECT

6TH OF OCTOBER CITY

The Square Mall project in 6th of October City stands as a testament to our commitment to excellence in commercial construction. Designed to provide a modern and dynamic shopping experience, this project progressed through multiple phases—from meticulous planning to full-scale construction and final delivery.

FROM CONCEPT TO COMPLETION

6TH OF OCTOBER AIRPORT BUILDINGS

Project stands as a testament to our commitment to excellence in construction and engineering. From initial planning to final delivery, this project exemplifies precision, innovation, and adherence to the highest industry standards.





BETA GARDENS VILLAS

NEW CAIRO

Beta Gardens Villas in New Cairo is a testament to our expertise in delivering high-quality residential projects from inception to completion. Designed to combine modern elegance with practical functionality, this development reflects our commitment to excellence in planning, construction, and timely delivery.



Property Finishing

We transform spaces into functional and visually stunning environments. Our property finishing services include:



Interior Design:

Customized designs for residential, commercial, and hospitality spaces, focusing on aesthetics, functionality, and comfort.



Exterior Design:

Facade design, landscaping, and outdoor spaces that enhance the overall appeal of the property.



Smart Home Automation:

Integration of advanced technologies for lighting, security, climate control, and entertainment systems. We work with leading brands such as HDL, Loxone, and Zenio to deliver cutting-edge solutions.





INTERIOR DESIGN

We handle every aspect of interior design, including space planning, material selection, color palettes, and furnishings, ensuring a cohesive and harmonious environment. Whether for residential or commercial projects, our approach combines aesthetics with practicality, maximizing both comfort and functionality.





What

Makes Us Different

In the extreme built environment of Middle East, what makes us different is to bring "NATURE" in our designs as people are moving away from it. Our vision is to bring humanity back to its origin that is NATURE. In order to do that we try to bring harmony between inside and outside, being close to true forms by using materials in their original forms.

OUR DESIGN STRATEGY

“ Nature holds the key to our aesthetics, intellectual, cognitive and even spiritual Satisfaction ”



Interior Designs

our interior design services are dedicated to creating inspiring spaces that elevate both functionality and aesthetics. We understand that every project is unique, & our team of skilled designers collaborates closely with clients to bring their visions to life. From clever space planning and material selection to custom furnishings and finishes, we strive to craft environments that reflect individual styles while enhancing quality of life.



With a commitment to excellence and an eye for detail, we transform interiors into welcoming and stylish havens. Whether residential or commercial, we take pride in delivering exceptional designs that exceed expectations and stand the test of time



**DESIGNING INTERIORS
THAT REFLECT YOUR STYLE**





THE DESIGN
makes you look
different



THERE IS NO RULES WHILE DESIGNING A CONTEMPORARY HOME

A space where the interiors are easy on the eyes with trending elements is what contemporary designs are all about. In essence, contemporary living rooms have interiors that are TRENDING right now.



**ATTRACTIVE
DESIGNS**



WE PROVIDE
DESIGNS TO SUIT
ALL TASTES





STYLE

SCANDINAVIAN

Choosing the white color for the walls as a basic color and combining it with some light and dull colors or nude shades of all colors.



MODERN BATHROOM DESIGN





EXTERIOR DESIGN

In building, exterior design services focus on enhancing the curb appeal and functionality of your property. We understand that the exterior of a building is the first impression, and we strive to create captivating designs that reflect our clients' vision while complementing the surrounding environment.

Our team of skilled designers collaborates with clients to develop cohesive exteriors that include architectural finishes, landscaping, hardscaping, and façade treatments. We prioritize the use of high-quality materials and sustainable practices, ensuring that the final design is both aesthetically pleasing and durable.





**EXTERIOR DESIGNS
THAT INSPIRE AND ENDURE**

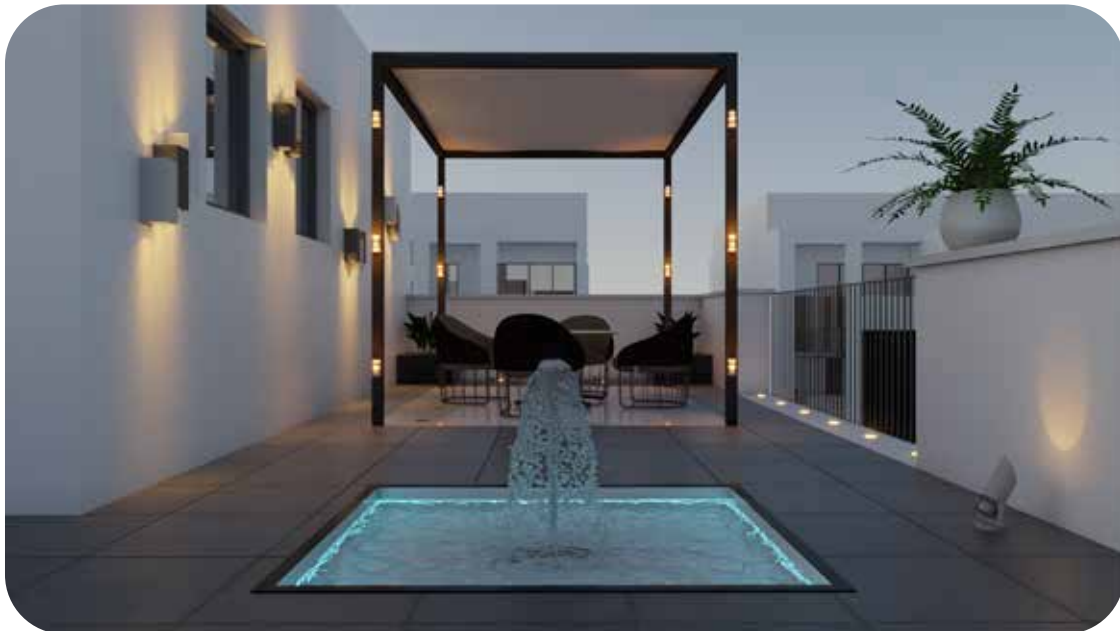



BRINGING GREEN TO LIFE



Interior Finishes

our interior finishing services focus on transforming spaces into beautiful, functional environments that reflect the unique style and preferences of our clients. With a commitment to quality and artistry, we enhance the aesthetics and comfort of every interior.





Exterior Finishing

we take pride in our attention to detail and our commitment to delivering exceptional exterior finishing that transforms properties into stunning, durable homes. Our collaborative approach ensures that every project aligns with our clients' vision and enhances their living experience.





Smart Home Automation

- In today's fast-paced world, convenience, security, and energy efficiency are at the core of modern living. At iBuilding we specialize in cutting-edge Smart Home Automation solutions that seamlessly integrate technology into your home or business.
- Our smart systems allow you to control lighting, security, climate, and entertainment with just a touch or voice command anytime, anywhere.
- Whether it's optimizing energy consumption, enhancing security, or creating a personalized living experience, we bring intelligence to your space with innovative and reliable automation solutions.
- Transform your home into a smarter, safer & more efficient environment with iBuilding where technology meets comfort.





ADVANTAGES

Of Smart Home Automation



Convenience:

Control multiple devices from a single app, automating daily tasks for a seamless experience.

Energy Efficiency:

Optimize energy usage with smart devices, leading to reduced utility bills and a smaller carbon footprint.

Security:

Enhance home safety with integrated smart locks, cameras, and alerts for real-time security monitoring.

Remote Access:

Manage and monitor your home from anywhere with mobile devices, providing flexibility and peace of mind.

Increased Home Value:

Smart features are increasingly desirable in real estate, boosting the appeal and value of properties.

Personalization:

Tailor settings for lighting, temperature, and entertainment to suit individual preferences and lifestyles.

Improved Well-being:

Promote a healthier environment with features like air quality monitors and customized lighting.

Our Automation Systems



Currently our product portfolio consists of three comprehensive automation systems, namely, Buspro, Buspro Wireless and KNX. These are distributed systems that can connect with most electrical devices and appliances in a building, LED lamps, for example, and allow users to control them on a wall panel, mobile app or a PC. With the help of sensors and logic settings, tasks can also run automatically without user interference.

Buspro is a wired system that runs HDL's proprietary protocol while Buspro Wireless is a wireless one as you can see from its name. In addition, HDL is also a manufacturer member of KNX International and a board member of KNX China, hence we also provide KNX system products.



buspro

- A powerful and flexible automation system

Buspro is able to connect with conventional non-smart devices covering the features of lighting, shading, air-conditioning, heating, background music, security, etc. It allows users to control all the features on one unified interface – an app or a wall panel.

With the help of gateways or software integration, Buspro can also work with third-party smart systems or standalone products such as smart door locks, smart speakers and more. It can be used in various types of buildings like homes, office buildings, urban complexes, large gymnasiums and hotels. Users can decide the functions and scale of the system according to their needs.

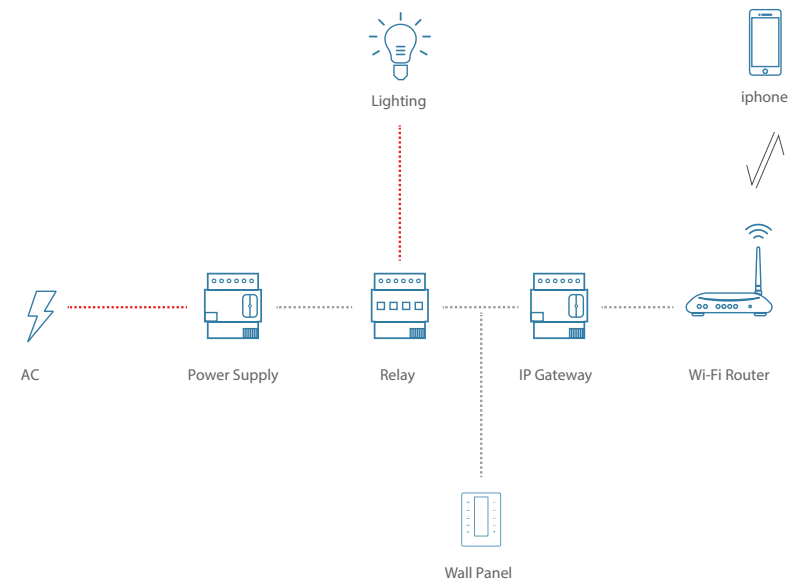



- A worldwide standard for home and building control

KNX is a worldwide standard for home and building control. Solutions based on KNX are widely adopted around the globe. As a manufacturer member of KNX, HDL offers high quality KNX products to the market. Most of our KNX products are used in office buildings, large gymnasiums, urban complexes, hotels right now. But we are trying to apply KNX in more industries such as home automation.





- With a proven track record in Smart Home Automation, IBuilding has successfully transformed numerous residential and commercial spaces into intelligent, efficient, and secure environments.
- Our expertise, combined with cutting-edge technology and a commitment to excellence, has positioned us as a trusted leader in the industry.
- Through our innovative solutions, we have enhanced the way people interact with their homes workplaces offering unparalleled convenience, energy efficiency, & security.
- As we continue to grow, our dedication to delivering high-quality, customized automation solutions remains unwavering.

PARTNER WITH
IBuilding and experience
THE FUTURE OF
Smart living today.



Electromechanical Works

iBuilding provides state-of-the-art electromechanical solutions tailored to meet the needs of modern infrastructure

OUR SERVICES INCLUDE:



Engineering



Electrical Works



Mechanical Works





ENGINEERING

Success stems from its dedication to provide customers with proven professional services and cost effective solutions driven by transparency.

- Conceptual and preliminary engineering
- Evaluation of tender documents
- Design review and value engineering
- Project cost estimation
- Equipment and materials procurement
- Planning and scheduling
- Detailed design & shop drawings
- Inspection, quality assurance and control
- Testing & commissioning
- Operator training

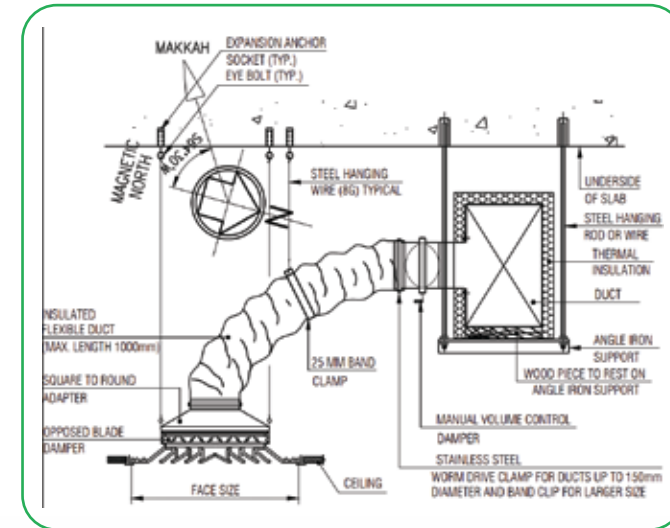

DIFFUSER INSTALLATION DETAIL

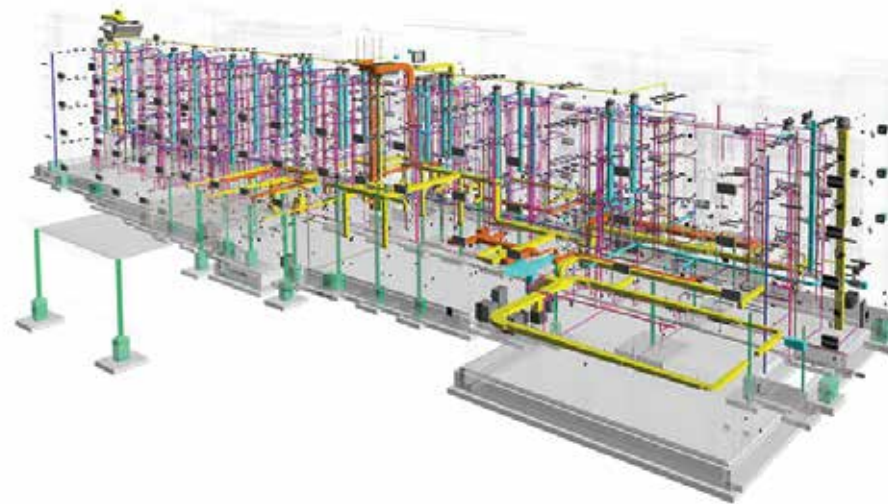



ELECTRICAL WORKS

Electrical works are crucial for safe and efficient power distribution in homes, businesses, and industries. Proper installation, maintenance, and innovation ensure reliability, energy efficiency, and sustainability in modern infrastructure

Low Current Systems: Design and installation of CCTV, access control, fire alarm systems, data networks, and intercom systems.

Electrical Panels : Design, supply, and installation of electrical distribution panels tailored to project requirements.

Lighting Solutions: Energy-efficient lighting design and installation, including LED systems and smart lighting controls.

Power Distribution: Reliable and safe power distribution systems for residential, commercial, and industrial applications.



Low Current Systems:

Design and installation of CCTV, access control, fire alarm systems, data networks, and intercom systems.

- Closed Circuit Television System (CCTV)
- Mass Antenna Television (MATV)
- Fire Alarm System
- Building Management System (BMS)
- Public Address System
- Internet Protocol (IP) Systems
- European Installation Bus (EIB) Systems
- Nursing Call System



Electrical Panels :

Design, supply, and installation of electrical distribution panels tailored to project requirements.

Reliable electrical panel supply is the backbone of any efficient power distribution system. Choosing high-quality panels ensures safety, performance, and longevity for industrial, commercial, and residential applications. By sourcing from reputable suppliers, businesses can minimize downtime, enhance operational efficiency, and comply with industry standards.

Investing in the right electrical panels today means securing a stable and reliable power infrastructure for the future. Whether for new installations or upgrades, working with experienced suppliers guarantees tailored solutions that meet your specific electrical needs.



PANELS

- 01 PRISMA PANEL
- 02 MCC PANEL
- 03 MDB PANEL
- 04 ATS PANEL
- 05 SYNCH PANEL
- 06 CAPACITOR BANK



“WE HAVE
SERVICES TO MEET YOUR
EQUIPMENT’S NEEDS,
THROUGHOUT
ITS LIFE CYCLE”



LV Main
switchboard



Sub-Main
switchboard 630A



Final Distribu on
Board up to 250A

Lighting Solutions:

Energy-efficient lighting design and installation, including LED systems and smart lighting controls.

1. Residential Lighting
2. Commercial & Industrial Lighting
3. Outdoor & Landscape Lighting
4. Smart & Energy-Efficient Lighting



Power Distribution :

Reliable and safe power distribution systems for residential, commercial, and industrial applications

1. Power Distribution System Design & Installation
2. Low & Medium Voltage Solutions
3. Energy Management & Efficiency Solutions
4. Maintenance & Emergency Support





MECHANICAL WORKS

Mechanical works are essential for efficient systems, infrastructure, and industries. They ensure functionality, safety, and sustainability through advanced design, installation, and maintenance. As technology evolves, mechanical solutions continue to enhance productivity and efficiency across various sectors.



Mechanical Works

Plumbing Systems: Design and installation of water supply, drainage, and sewage systems, ensuring efficiency and sustainability.

HVAC Systems: Heating, ventilation, and air conditioning solutions for optimal comfort and energy efficiency.

Fire Protection Systems: Installation of fire suppression and alarm systems to ensure safety and compliance with regulations.



Plumbing

Building puts lots of emphasis to ensure that every plumbing system installed is equipped with valve assemblies and devices for the proper distribution of water.

Our Designers always assure to implement global and KSA regulations and standards to guarantee delivering best quality.

The plumbing systems that We specializes in:

- Sanitary and drainage systems
- Water distribution
- Water treatment
- Solar Heaters
- Kitchen and laundry plumbing
- Irrigation systems and controls
- Sand traps and grease traps

HVAC SYSTEMS

Mechanical Works

We install, maintain & repair climate control systems in thermal comfort and maintaining good indoor air quality is our main purpose.

IBuilding Electromechanical Works strives to install systems with the perfect quality-cost balance that successfully provides superior air quality while incurring low energy costs & allowing easy maintenance.

What sets us apart is that our team undergoes continuous extensive training that is unmatched in the industry & maintain systems, install controls, test individual parts, and replace worn-out components.





Services & solutions include:

- Chilled water systems
- DX / VRV systems
- Package units
- Extract fans
- Fresh Air Handling Units
- Ecology Units and Make up Air Handling
- CCU
- GI and PI Ducting



FIRE PROTECTION SYSTEMS

The reliable protection systems we install have one main purpose which is to prevent the interruption of services necessary for the public welfare and avoid area wide utmost priority.

- Fire suppression systems
- Fire extinguishers
- Fire hose reels
- Fire hydrant systems
- Automatic sprinkler systems
- Dry and wet riser





Rental Generators

We offer reliable rental generator solutions to meet your power needs during construction or emergencies. Our services include:

Short-term and Long-term Rentals: Flexible rental options to suit your requirements.

Installation and Maintenance: Professional installation and regular maintenance to ensure optimal performance.

Custom Solutions: Tailored generator solutions for specific project needs.



ENERGY SOLUTIONS

Fully equipped with large fleet of generators, transformers, air compressors, welding machines, light towers and accessories providing temporary power solutions

Industries we serve

CIVIL & CONSTRUCTION

MARINE / OFFSHORE

OIL & GAS

MANUFACTURING

PETROCHEMICAL

POWER

SHIPPING & LOGISTICS



Our Services

SALE

RENT

INSTALLATION

MAINTENANCE



We are supply the power from 50 KVA up to 8,000 KVA . With all accessories including the Electrical Scope

Our Services for the most of popular brand (Caterpillar , Cummins , Perkins) to Do From BM Services to Complete Overhauling



MAINTENANCE & INSTALLATION

we provide professional generator installation and maintenance services to ensure reliable and uninterrupted power supply for residential, commercial, and industrial applications.



Our Installation Services :

- Expert assessment to determine the right generator size and type.
- Professional installation with adherence to safety and industry standards.
- Seamless integration with existing electrical systems.



Our Maintenance Services :

- Regular inspections and preventive maintenance to enhance efficiency.
- Oil and filter changes, coolant checks, and battery testing.
- Load testing and troubleshooting to prevent unexpected failures.
- 24/7 emergency support to minimize downtime.





Steel Fabrication

iBuilding excels in custom steel fabrication, delivering durable and precise solutions for various applications. Our services include:

Fuel Tanks: Design and fabrication of fuel storage tanks for industrial and commercial use.

Soundproof Canopies: Noise-reducing enclosures for generators and equipment, ensuring minimal noise pollution.

Trailers & waste Containers: Fabrication of 4-wheel and 2-wheel trailers for transportation and logistical needs and Defrint sizes of waste containers.

Maintenance and Installation: Regular maintenance and installation services to ensure longevity and performance.



FUEL TANKS

Diesel fuel tank manufacturing ensures durability, safety, and compliance with industry standards. Using high-quality materials and precision engineering, the process includes fabrication, welding, coating, and testing to guarantee reliable fuel storage for various industries.



Design & Material Selection

Choosing high-quality materials and specifications.

Cutting & Forming

Shaping materials to required dimensions.

Welding & Assembly

Joining components for structural integrity.

Surface Treatment & Coating

Applying protective layers for durability.

Testing & Quality Control

Ensuring safety and compliance with standards.

SOUNDPROOF CANOPIES

We specialize in manufacturing high-quality soundproof canopies for generators, ensuring noise reduction, durability, and weather protection. Our process includes fabrication, insulation, ventilation, and rigorous testing for optimal performance.

Design & Material Selection

Choosing high-quality, sound-absorbing materials.

Cutting & Fabrication

Shaping and assembling the canopy structure.

Insulation Installation

Adding noise-reducing and thermal insulation.

Ventilation & Access Features

Ensuring proper airflow and maintenance access.

Coating & Finishing

Applying protective coatings for durability.

Testing & Quality Control

Verifying noise reduction, durability, and compliance.



TRAILERS & WASTE CONTAINERS



Trailer Manufacturing:

We specialize in manufacturing durable and high-performance trailers for various industries. Our process includes design, fabrication, welding, surface treatment, and quality testing to ensure strength, stability, and long-lasting performance.



Waste Container Manufacturing:

We produce robust waste containers designed for efficient waste management. Using high-quality materials, our process includes cutting, welding, coating, and rigorous testing to ensure durability, corrosion resistance, & compliance with industry standards.

LET'S BUILD TOGETHER

At iBuilding, we are committed to turning your vision into reality. Whether it's a construction project, property finishing, smart home automation, or electromechanical solution, we deliver excellence at every step. Contact us today to discuss your next project!

Why Choose iBuilding

18+ Years of Experience: A proven track record of successful projects across multiple sectors.

Comprehensive Services: From construction to finishing, smart home automation, and electromechanical works.

Quality Assurance: Adherence to international standards and best practices .

Customer-Centric Approach: Tailored solutions to meet client needs and exceed expectations.

Skilled Team: team consists of passionate individuals who are committed to excellence. Each member brings unique expertise and a drive for innovation, making us a powerhouse of creativity and problem-solving.

OUR PARTNERS

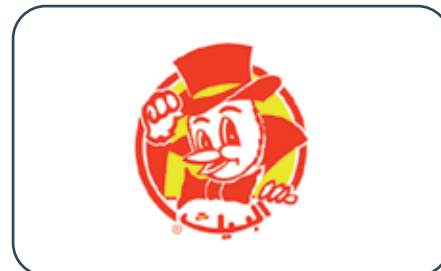

OUR PARTNERS





CONTACT US

Call Now

Social Media



+966 500 866 002



info@ibuildingco.com



www.ibuildingco.com



Saudi Arabia

PO Box 12221-6661 Al Olaya- 2605
Al Olaya Dist -Riyadh, Kingdom of
Saudi Arabia



Egypt

6 October, Al Mehwar Al Markazi,
October Trade Center, Building 4,
Flat 31

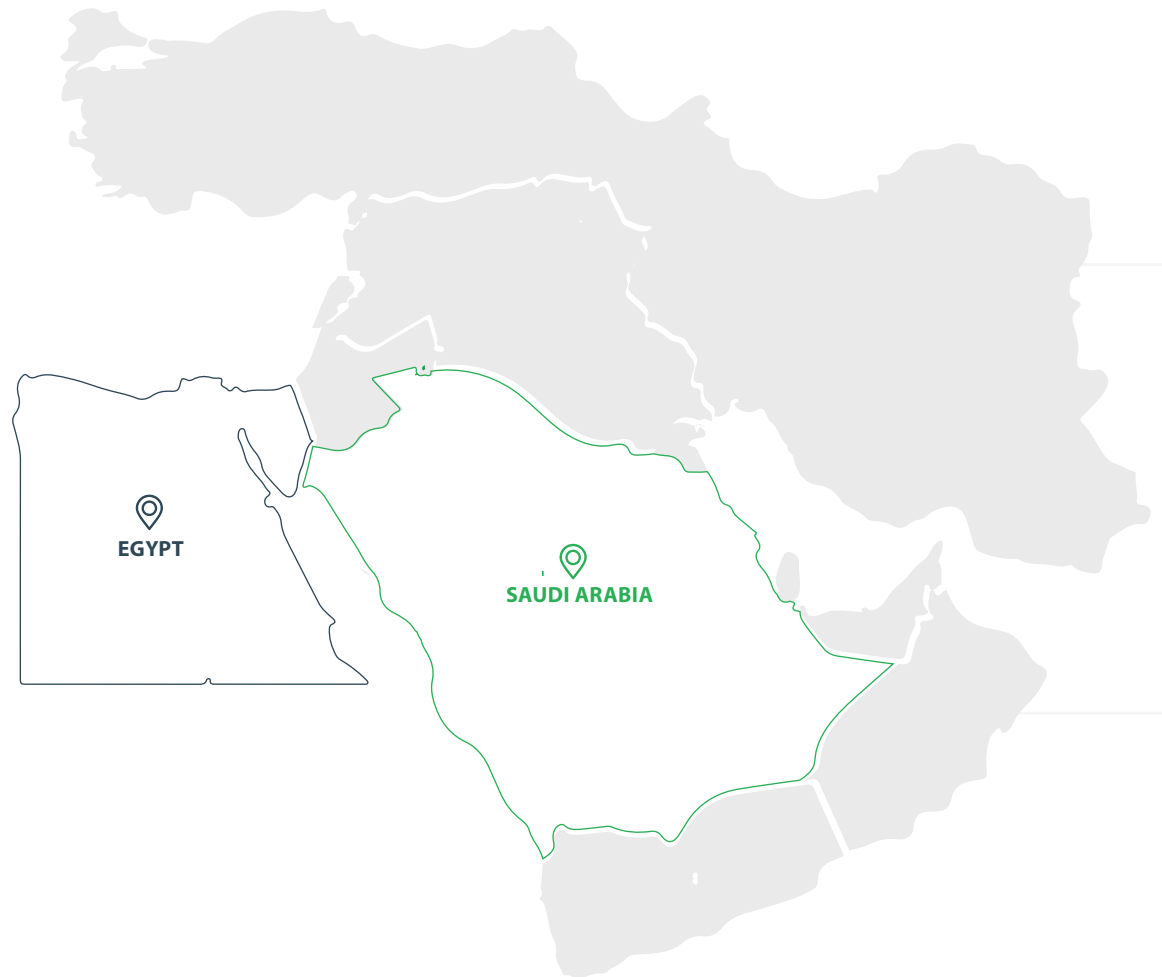



شركة بناء الطاقة للمقاولات
IBuilding Contracting Co.



شركة بناء الطاقة للمقاولات
IBuilding Contracting Co

COMPANY PROFILE
**IBUILDING
CONTRACTING**

CONTACT US

- +966 500 866 002
- info@ibuildingco.com
- www.ibuildingco.com